

17011EBM2X26

6" – 2X26W Fluorescent Horizontal Lamp

Product Description

Suitable for new construction in residential and commercial applications.
NON-IC. Insulation must be kept a minimum of 3" from housing.
Use two 26W double twin tube, G24Q-1 (not included).

Construction

120-277V Universal input electronic ballast.
Commercial frame allows direct installation to wood joist or steel stud constructions.

Plaster Frame

Housing is secured to plaster frame with screws and can be removed for access to junction box.
Housing adjusts from 1/2" to 1 1/2" to ac

Junction Box

Listed for through branch circuit wiring and includes several 3/4" knockouts. Four pry-outs with integral strain relief simplify Romex installation.
Supplied with three IDEAL® push-in wire connectors.

Installation

Heavy-gauge NICOR captive hanger bars provide greater stability, allowing housing to be positioned at any point within a 24" joist span, then locked in place with set screws. Unique hanger bar lip design helps align can to joist. Four double-headed captive nails provide for ease of installation.

Bars can be repositioned 90° on plaster frame without tools.

Bars fit onto T-bar spine for quick alignment and can be permanently secured.

Score lines allow bars to be shortened without tools to accommodate a 12" joist span.

Project

Catalog

Type

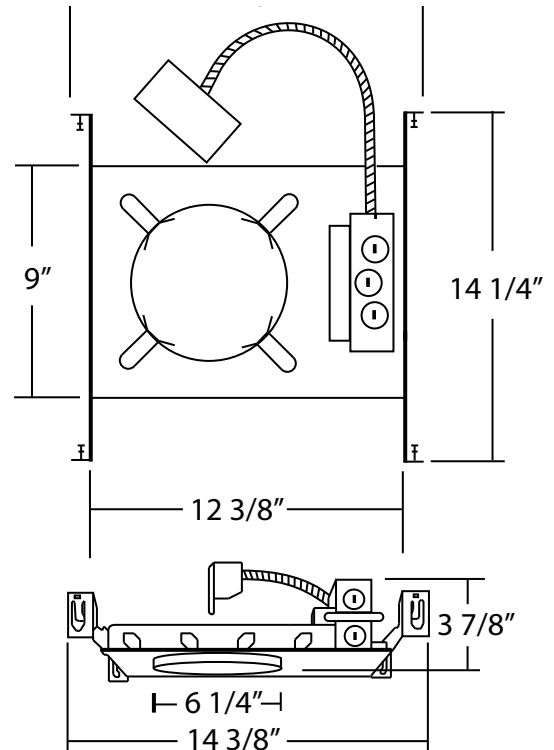

17011EBM2642

6" 2X26W Fluorescent Horizontal Frame-In

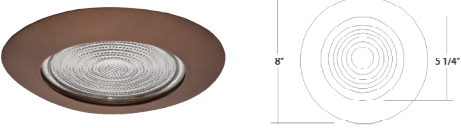
Lexan Shower Fresnel Lens	Order No	Color	Maximum Lamp Rating
	17502BZ	Bronze (shown)	OD: 8" Wet Location Rated
	17502R	White (with reflector)	
	17502OB	Oil-Rubbed Bronze	
	17502	White (with metal trim ring)	
	17572WH	White (with plastic trim ring)	

Lexan Drop Opal	Order No	Color	Maximum Lamp Rating
	17509R	White (with reflector)	OD: 8" Wet Location Rated
	17509	White (shown with metal trim ring)	
	17509WH	White (with plastic trim ring)	

Frame Insert	Order No	Color	Maximum Lamp Rating
	17600	Requires Trim	OD: 7 1/2"

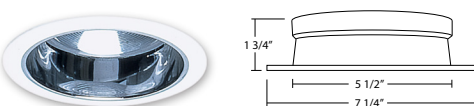
Reflector Fresnel Lens	Order No	Color	Maximum Lamp Rating
	17604	Clear	OD: 7 1/4" Also requires 17600 Frame Insert

Reflector	Order No	Color	Maximum Lamp Rating
	17607BK	Black (shown)	OD: 7 1/2"
	17607CL	Clear	
	17607GD	Gold	
	17607WH	White	

Baffle Reflector	Order No	Color	Maximum Lamp Rating
	17620BK	Black (shown)	OD: 7"
	17620WH	White	

17011EBM2642

6" 2X26W Fluorescent Horizontal Frame-In

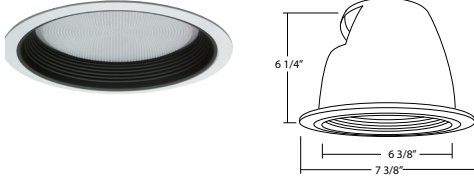
Lexan Shower Fresnel Lens	Order No	Color	Maximum Lamp Rating
	17623BK	Black (shown)	OD: 7 3/8" Wet Location Rated
	17623WH	White	

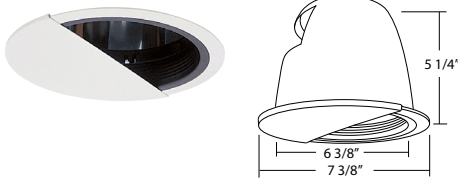
Baffle Wall Wash	Order No	Color	Maximum Lamp Rating
	17627BK	Black (shown)	OD: 7 3/8"
	17627WH	White	

Frame Insert	Order No	Color	Maximum Lamp Rating
	17638CL	Clear	OD: 7 3/8"

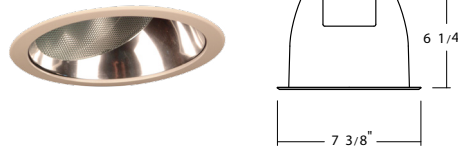
Reflector	Order No	Color	Maximum Lamp Rating
	17644CL	Clear	OD: 7 3/8"
	17644GD	Gold (shown)	

Reflector Louver	Order No	Color	Maximum Lamp Rating
	17645CL	Clear (shown)	OD: 7 3/8"
	17645GD	Gold	

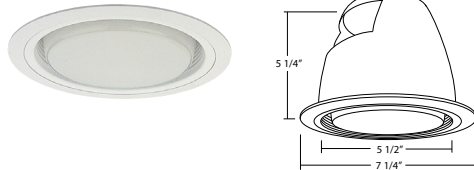
Baffle Drop Opal	Order No	Color	Maximum Lamp Rating
	17660BK	Black	OD: 7 1/4"
	17660WH	White (shown)	

Reflector Lifted Glass	Order No	Color	Maximum Lamp Rating
	17670BK	Black	OD: 7 3/8"
	17670WH	White (shown)	